

60mm sq.

San Ace 60

15mm thick (GA type), 15mm thick
 20mm thick (GA type), 20mm thick
 25mm thick (S type), 25mm thick (G type)
 25mm thick, 25mm thick (San Cooler)
 38mm thick (GA type), **38mm thick (GV type)**
 38mm thick (G type)



General Specifications

- Material Frame: Plastics (Flammability: UL94V-0),
 Impeller: Plastics (Flammability: UL94V-1)
- Expected Life Refer to specifications (L10:Survival rate:90% at 60°C ,
 rated voltage, and continuously run in a free air state)
- Lead Wire ⊕red ⊖black (Sensor) yellow (Control) brown
- Storage Temperature -30°C to +70°C (Non-condensing)

60×60×38mm [Mass : 130g] **GV type**

Specifications

The following nos. **have PWM controls, pulse sensors, and ribs.** For ribless, append "1" to the model no.

Model No.	Rated Voltage [V]	Operating Voltage Range [V]	PWM duty cycle※ [%]	Rated Current [A]	Rated Input [W]	Rated Speed [min ⁻¹]	Max. Air Flow [m ³ /min] [CFM]	Max. Static Pressure [Pa] [inchH ₂ O]	SPL [dB(A)]	Operating Temperature Range [°C]	Expected Life [h]	
9GV0612P1G03	12	8.0 to 13.8	100	2.8	33.6	16,000	2.37 84	751 3.02	66	-20 to +70	40,000	
			0	0.12	1.5	3,100	0.44 15	26 0.10	25			
100			2.0	24.0	14,500	2.15 76	617 2.48	63				
0			0.1	1.2	2,700	0.40 14	21 0.09	22				
9GV0612P1H03		100	1.5	18.0	13,000	1.93	68	496	1.99			60
9GV0612P1M03	10.8 to 13.8	100	0.7	8.4	10,000	1.49	52.6	293	1.17	52		
9GV0612P1L01 ^{Note1}												
9GV0624P1G03	24	20.4 to 27.6	100	1.4	33.6	16,000	2.37 84	751 3.02	66			
			0	0.12	2.88	6,000	0.89 31	105 0.42	38			
100			0.73	17.52	13,000	1.93 68.0	496 1.99	60				
0			0.08	3.84	6,000	0.89 31	105 0.42	38				
9GV0624P1M03 ^{Note1}		100	0.5	24	14,500	2.15	76	617	2.48	63		
											0	0.08
9GV0648P1H03	48	38 to 57	100	0.5	24	14,500	2.15 76	617 2.48	63			

Note : Fan does not rotate when PWM duty cycle is 0%.

※PWM Frequency : 25kHz

- Available options: ⇒ **Without Sensor** **Pulse Sensor**
- Please inquire as the availability of these functions depend on the model. ⇒ **Lock Sensor**

Dimensions (Unit : mm) (With ribs)

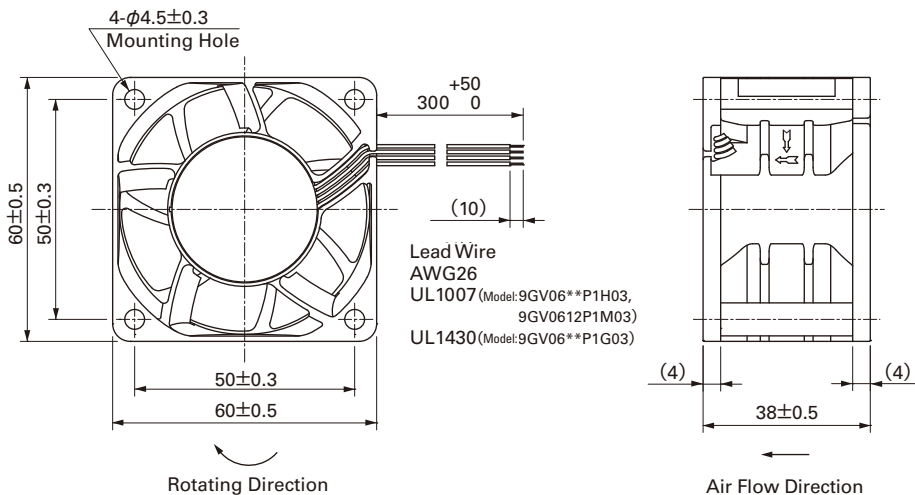

Reference dimension of mounting holes and vent opening (Unit : mm)

Inlet side, Outlet side

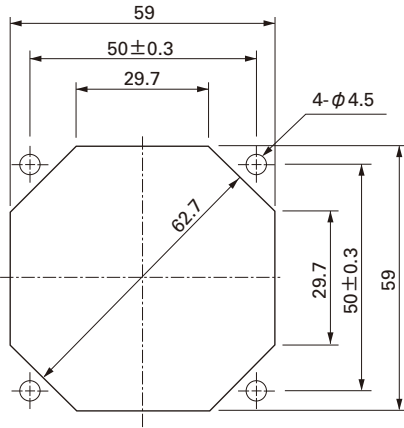

Options (Unit : mm)

Finger guards

Model : 109-139E Surface treatment : Nickel-chrome plating (silver)
 : 109-139H : Cation electropainting (black)

Color

Inlet side, Outlet side

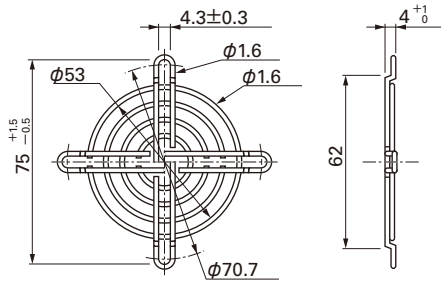

Resin finger guards

Model : 109-1003G

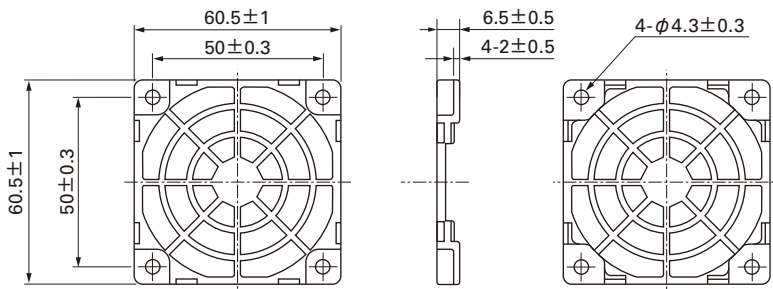

Resin filter kits

Model : 109-1003F13 (13PPI), 109-1003F20 (20PPI)
 : 109-1003F30 (30PPI), 109-1003F40 (40PPI)

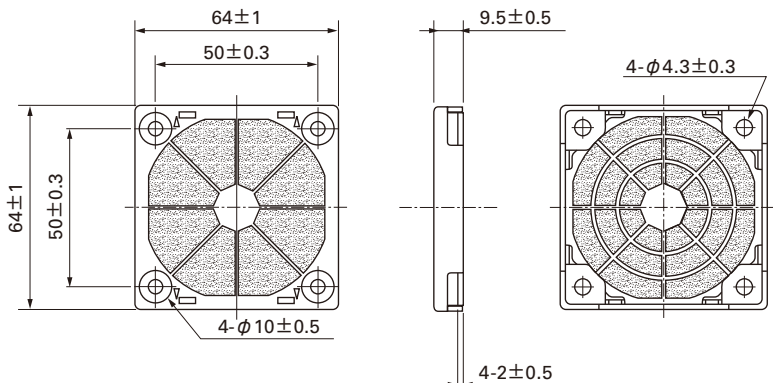

Air Flow - Static Pressure Characteristics

PWM Duty Cycle

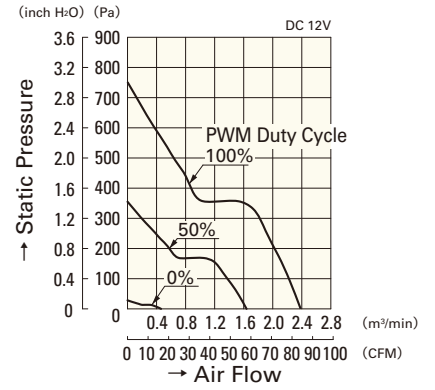

9GV0612P1G03

Operating Voltage Range

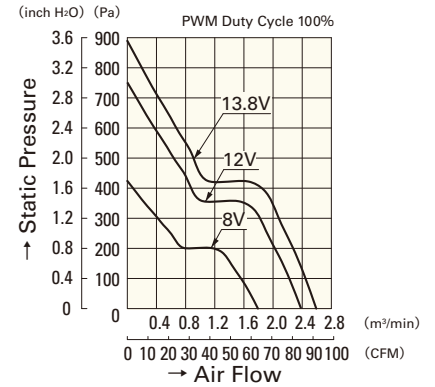

9GV0612P1G03

PWM Duty - Speed Characteristics Example

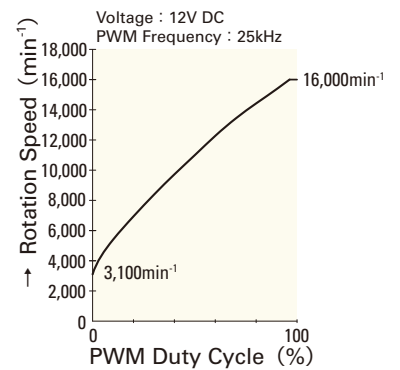

9GV0612P1G03

60mm sq.

San Ace 60

60×60×38mm [Mass : 130g]

Air Flow - Static Pressure Characteristics

PWM Duty Cycle

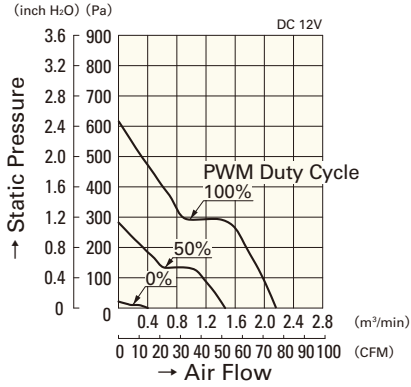

9GV0612P1H03

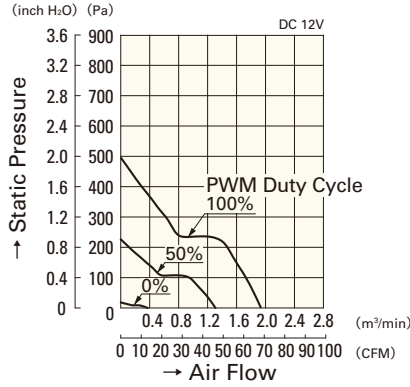

9GV0612P1M03

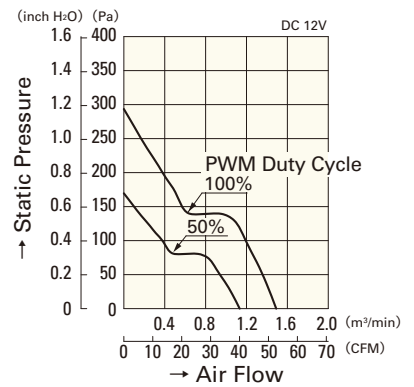

9GV0612P1L01

Operating Voltage Range

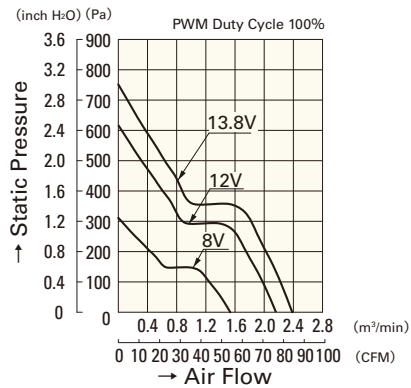

9GV0612P1H03

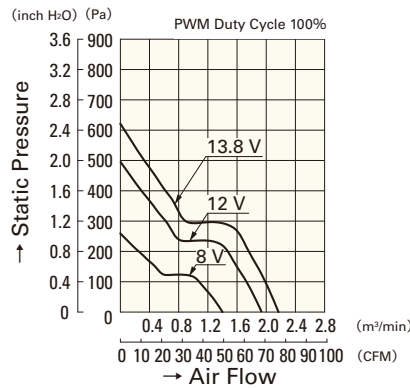

9GV0612P1M03

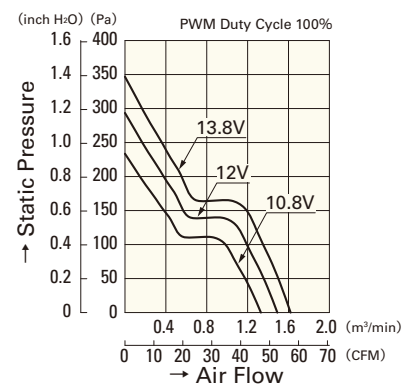

9GV0612P1L01

PWM Duty - Speed Characteristics Example

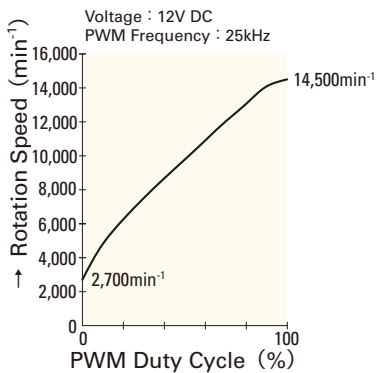

9GV0612P1H03

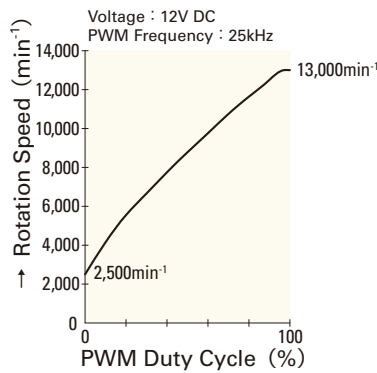

9GV0612P1M03

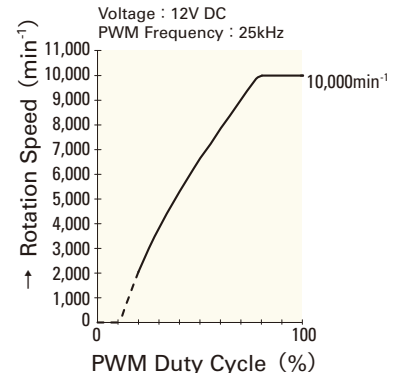

9GV0612P1L01

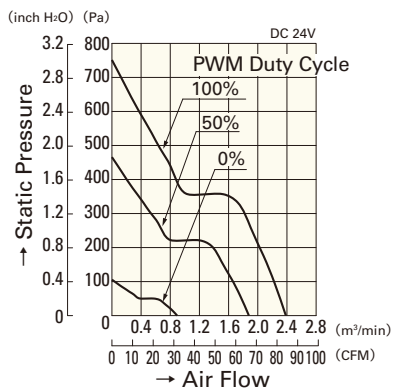

9GV0624P1G03

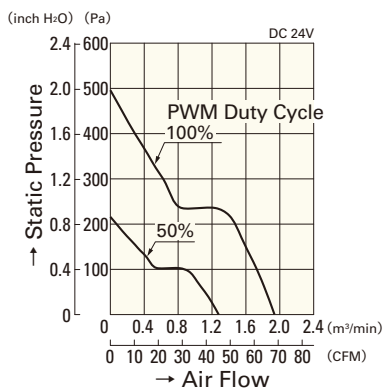

9GV0624P1M03

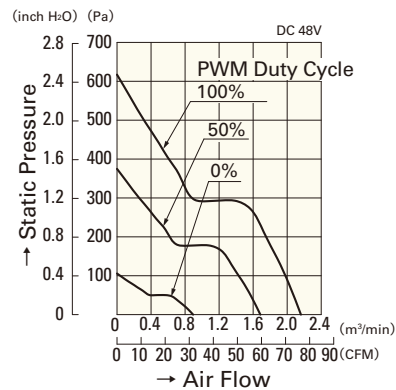

9GV0648P1H03

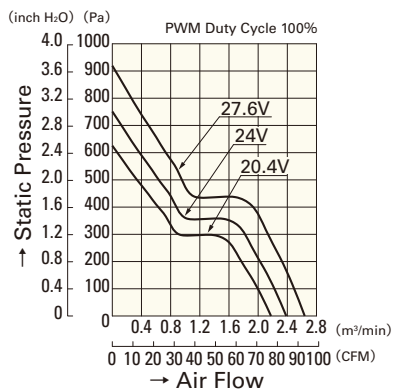

9GV0624P1G03

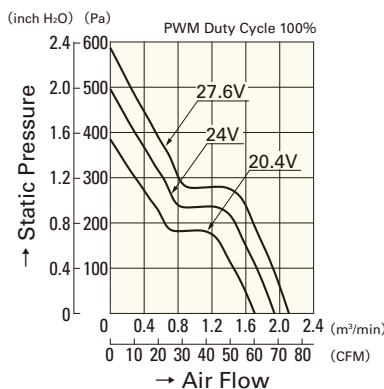

9GV0624P1M03

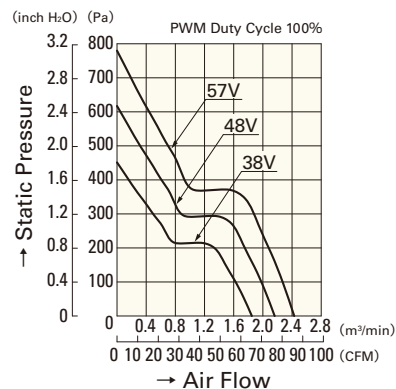

9GV0648P1H03

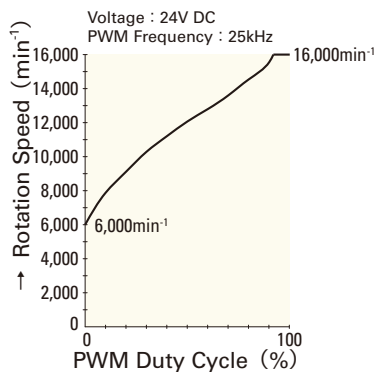

9GV0624P1G03

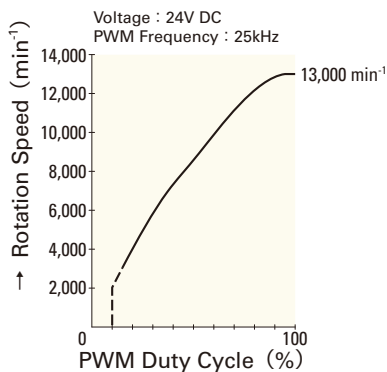

9GV0624P1M03

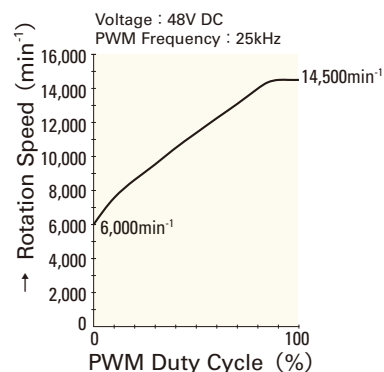

9GV0648P1H03